

Datasheet for #sb3239 DN

Recommendations:

Please read the starter kit user manual, if available, and have a look at the FAQ at <http://www.alpeslasers.ch/alfaqa.pdf>

WARNING: Operating the laser with longer pulses, higher repetition rate, higher voltage or higher current than specified in this document may cause damage. It will result in loss of warranty, unless agreed upon with Alpes Lasers!

WARNING: Beware of the polarity of the laser. This laser has to be powered with negative bias on the laser contact (= bonding pad, corresponding to the label "laser" on the LLH) and the positive bias on the base contact (= submount, corresponding to the label "base" on the LLH).

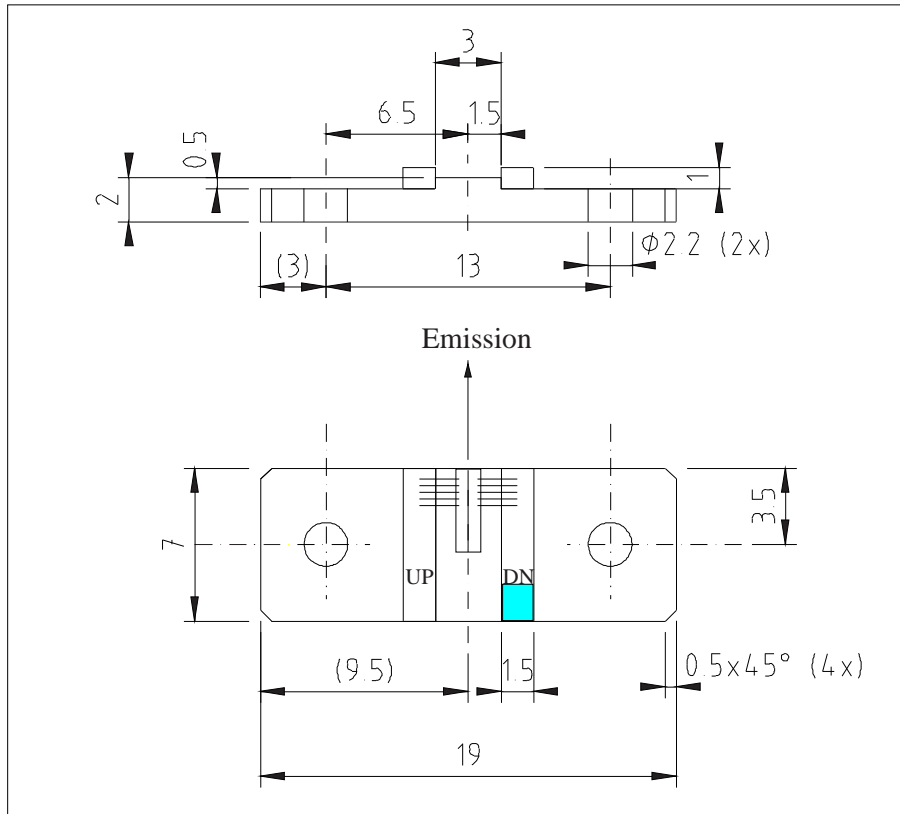

Figure 1: Support mounting for #sb3239 DN (please note that the laser is connected to the DN pad drawn in blue)

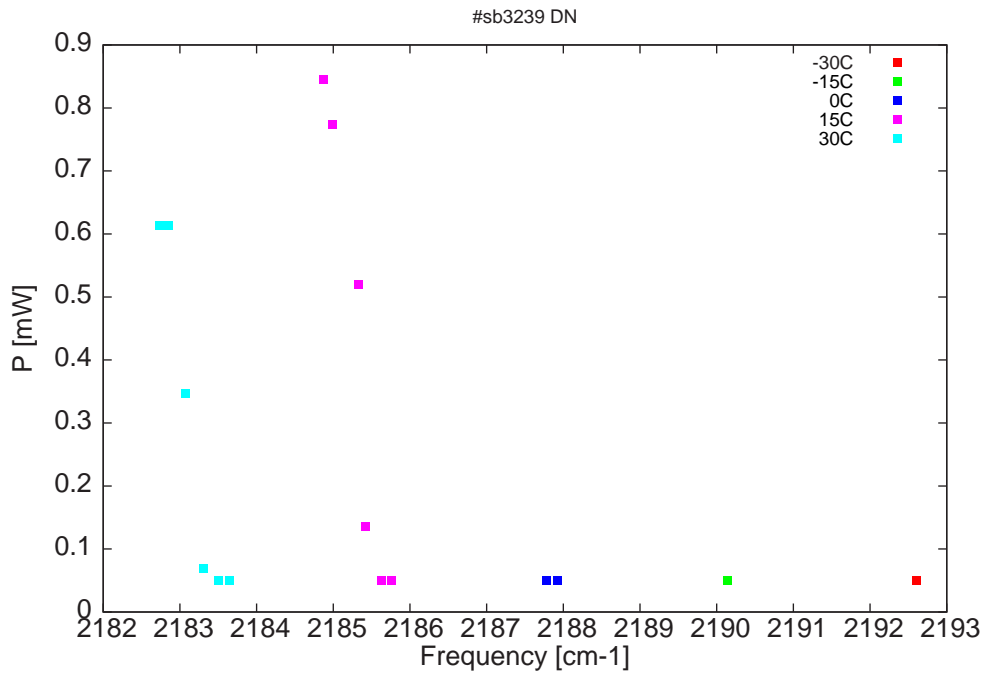

Figure 2: Output power as a function of the singlemode emission frequencies and temperatures

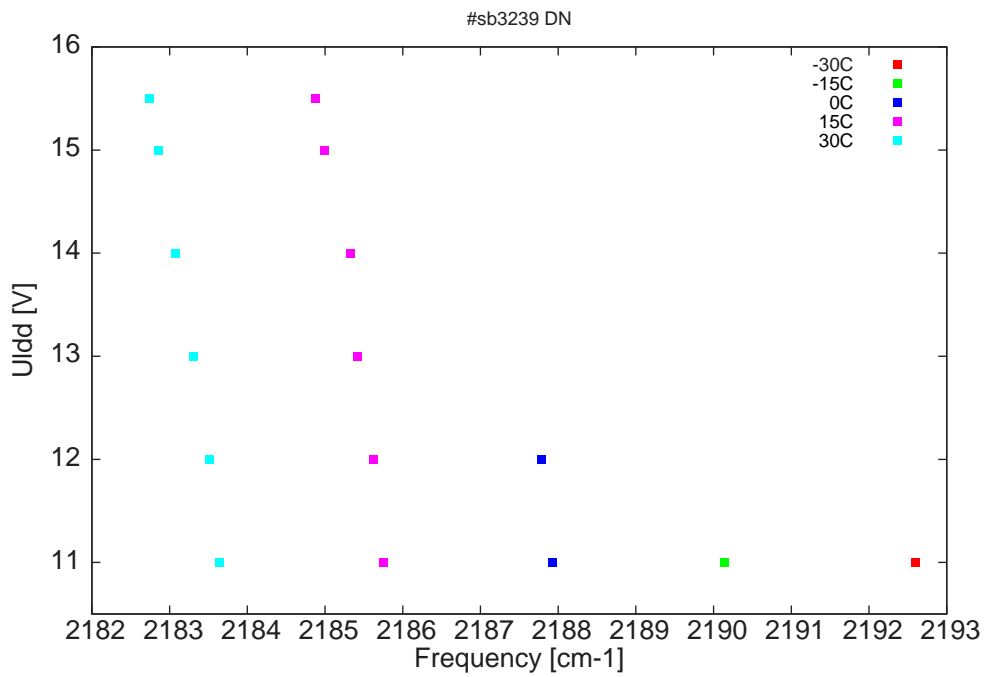

Figure 3: DC voltage fed to LDD (U_{ldd}) as a function of the singlemode emission frequencies and temperatures

λ [nm]	ν [cm ⁻¹]	P[mW]	Temp[°C]	U_{LDD} [V]	I_{pulse} [A]
4560.8	2192.6	0.1	-30	11	0.23
4565.9	2190.1	0.1	-15	11	0.25
4570.5	2187.9	0.1	0	11	0.26
4570.8	2187.8	0.1	0	12	0.38
4575.1	2185.8	0.1	15	11	0.28
4575.4	2185.6	0.1	15	12	0.39
4575.8	2185.4	0.1	15	13	0.52
4576	2185.3	0.5	15	14	0.68
4576.7	2185	0.8	15	15	0.85
4576.9	2184.9	0.8	15	15.5	0.96
4579.5	2183.6	0.1	30	11	0.3
4579.8	2183.5	0.1	30	12	0.4
4580.2	2183.3	0.1	30	13	0.52
4580.7	2183.1	0.3	30	14	0.7
4581.2	2182.9	0.6	30	15	0.93
4581.4	2182.7	0.6	30	15.5	0.97

Table 1 : singlemode optical output power as function of operating parameters

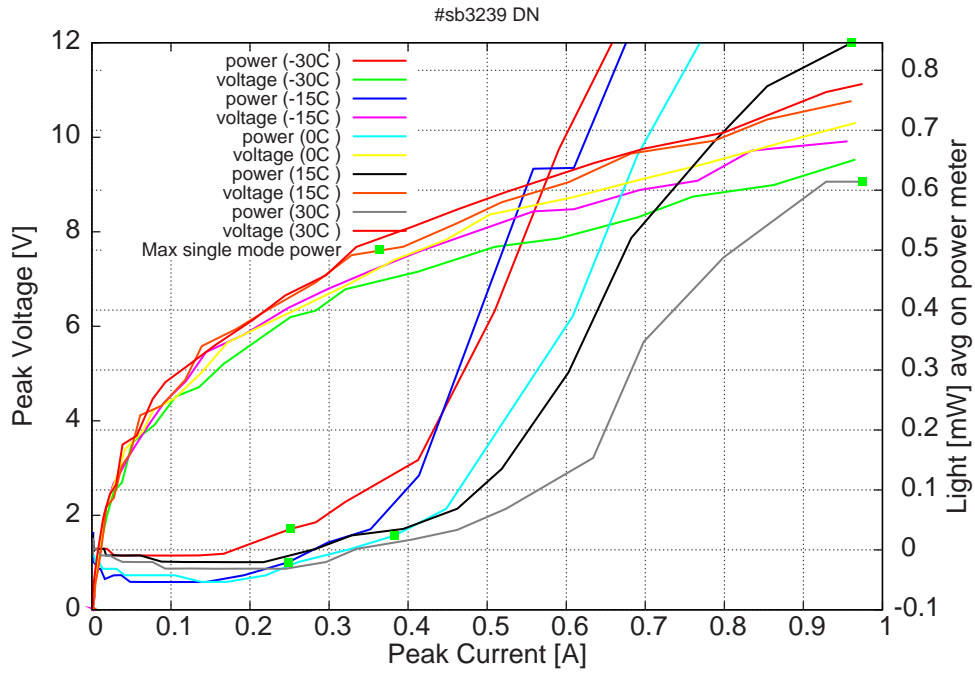

Figure 4: peak voltage and average power vs peak current at 2% duty-cycle (50ns pulses on the laser, 2.5 μ s period) (the solid squares indicate the maximum singlemode emitted power)

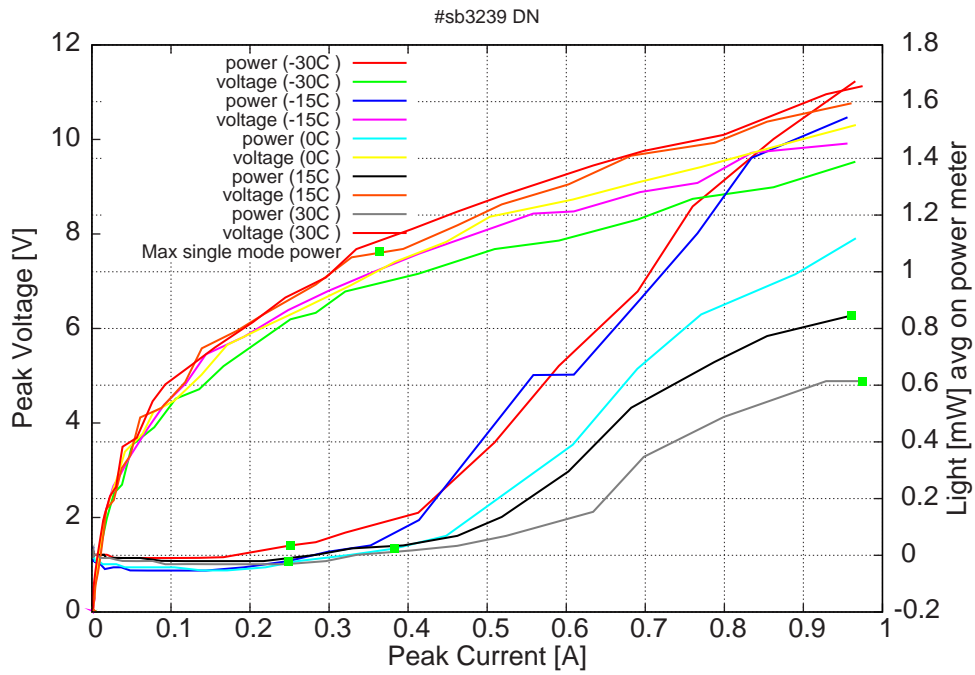

Figure 5: peak voltage and average power vs peak current at 2% duty-cycle (50ns pulses on the laser, $2.5\mu\text{s}$ period) (including the multimode region)

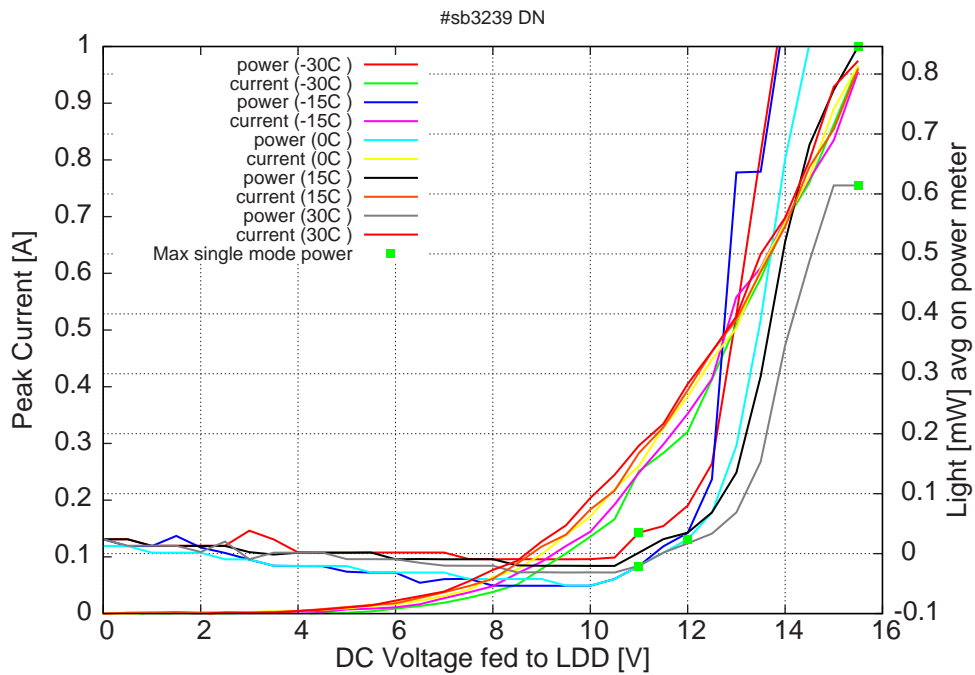

Figure 6: peak current and average power vs LDD voltage at 2% duty-cycle (50ns pulses on the laser, $2.5\mu\text{s}$ period) (the solid squares indicate the maximum singlemode emitted power)

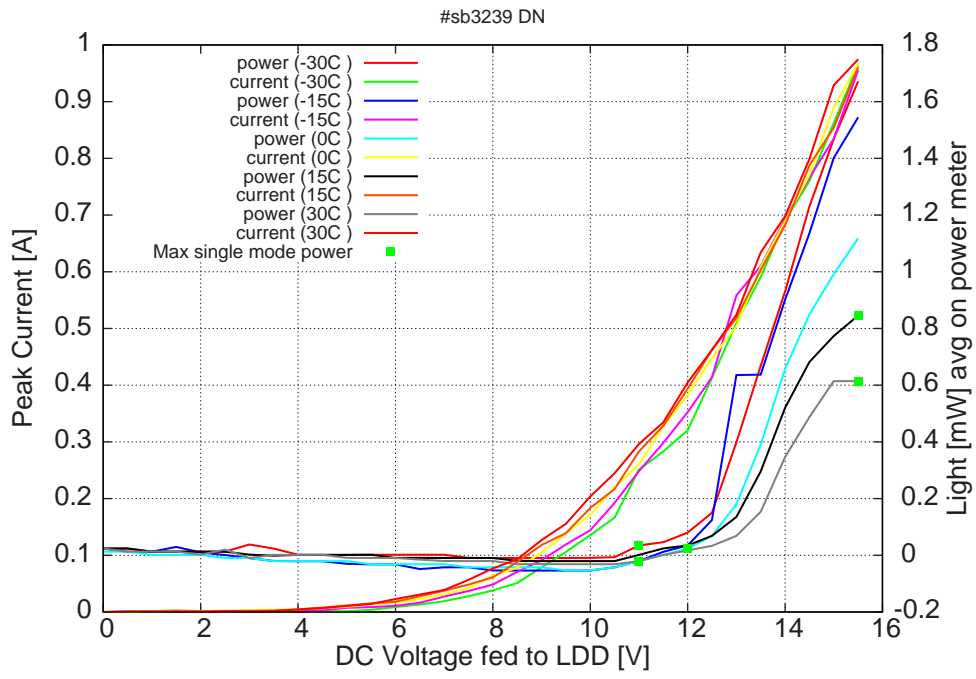
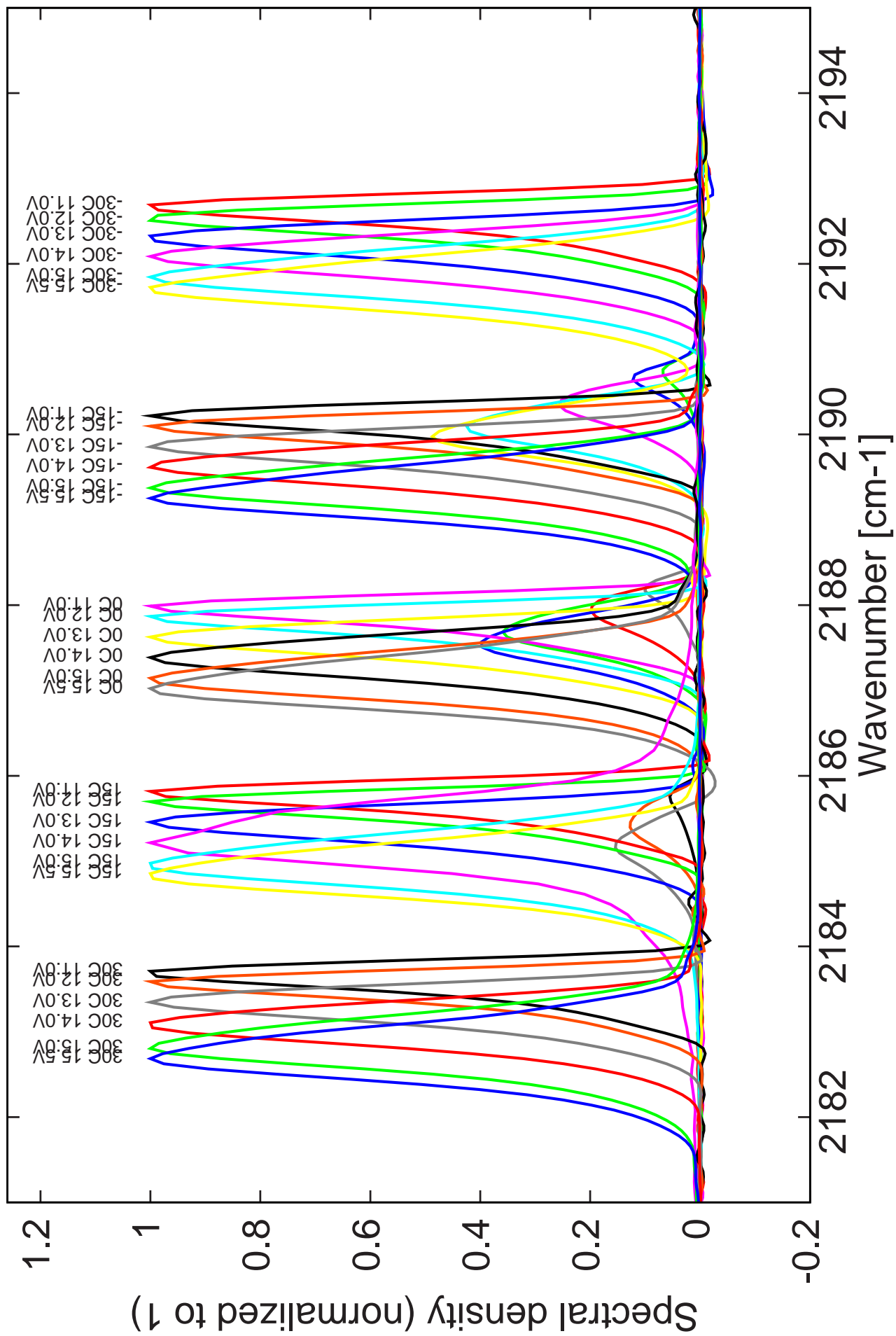

Figure 7: peak current and average power vs LDD voltage at 2% duty-cycle (50ns pulses on the laser, 2.5 μ s period) (including the multimode region)

Figure 6: spectra at different temperatures for various LDD voltages



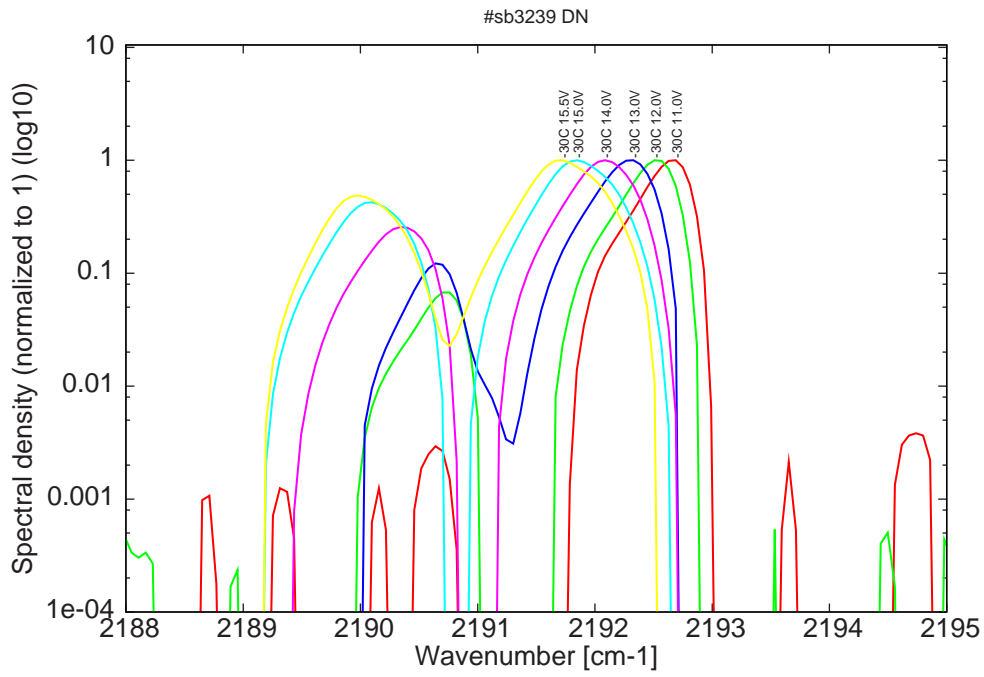

Figure 8: spectra at -30C for various LDD voltage (monomode only at threshold)

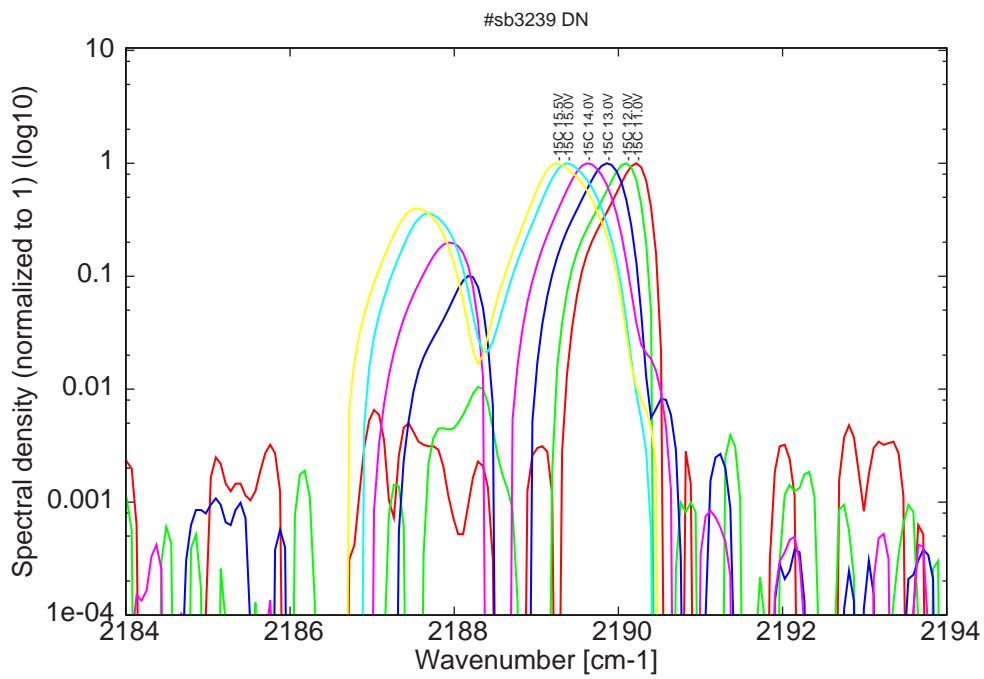

Figure 9: spectra at -15C for various LDD voltage (monomode only at threshold)

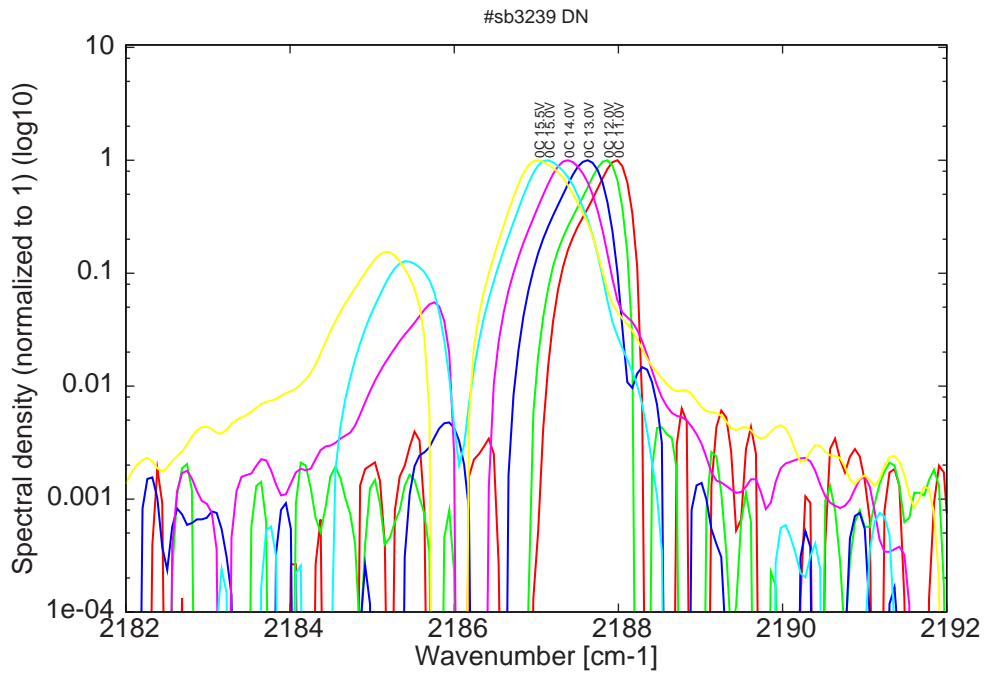

Figure 10: spectra at 0C for various LDD voltage (monomode up to 12.0V on LDD)

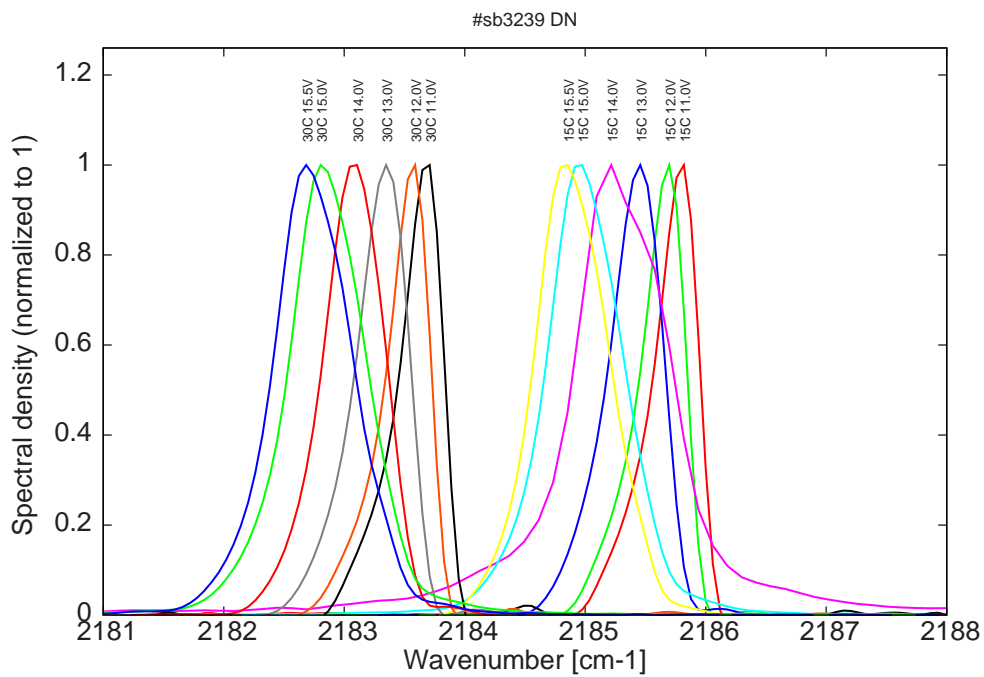

Figure 11: spectra between 15C and 30C for various LDD voltage (all monomode)