



S-4 HIGH COMPLIANCE CW DRIVER USER'S MANUAL



Version number 1.2
©2025 ALPES LASERS

This page intentionally left blank.

COPYRIGHT INFORMATION

This manual can be copied and distributed under the following conditions: the work must be attributed in the manner specified by the author or licensor, and cannot be altered or transformed.

WARRANTY

1. The customer must control the incoming deliveries and inform ALPES LASERS about incomplete shipments or defective goods within 30 days after delivery. ALPES LASERS warrants that the products respect the performance set forth in the quotation, provided that the product is used according to ALPES LASERS recommendations described in the datasheet included in the shipment.
2. Defective products will be replaced during the 2 years following delivery.
3. All other claims such as purchase refund, product reconditioning or damage of any nature, be it direct, indirect or consequential, are expressly ousted.
4. The customer is aware of laser products being devices with a statistical rate of failure. Depending on the use made of this product, it is the customer's responsibility to use caution, redundancy and appropriate technical measurement to ensure the final product's proper operation.
5. In case of discrepancy between the manual and terms written in the order confirmation, the order confirmation prevails.

CONTACT INFORMATION

Avenue des Pâquiers 1
2072 St-Blaise
Switzerland

Telephone:	+41 32 729 9510
Fax:	+41 32 729 9519
Email:	info@alpeslasers.ch
Web site:	http://www.alpeslasers.ch

DOCUMENT VERSION

This is Version 1.2 of the manual, published on Ferbruary 13th 2025. This version replaces v1.1 published on December 20th 2022..

Publication date	Version number	Changes
2025/02/25	1.2	Updated screenshots for firmware 1.80.
2022/12/20	1.1	Added fixed 32 mA additional soft-clamp current limit.

Quantum Cascade Laser Driver Instrument¹



TABLE OF CONTENTS

	PAGE
GENERAL OVERVIEW	2
SAFETY	3
QUICK CONNECT GUIDE	4
PIN DESCRIPTIONS	6
ELECTRICAL SPECIFICATIONS	7
OPERATING INSTRUCTIONS (STAND-ALONE)	9
REMOTE OPERATING INSTRUCTIONS	16
TROUBLESHOOTING	17
ADDITIONAL TECHNICAL NOTES	20
MECHANICAL SPECIFICATIONS	22

S - 4 SERIES

MODEL INFORMATION

500 mA Low Noise QCL Instrument
1.0 A Low Noise QCL Instrument
1.5 A Low Noise QCL Instrument
2.0 A Low Noise QCL Instrument



GENERAL OVERVIEW

- Output currents of 500 mA, 1 A, 1.5 A, 2 A
- Low noise: $0.4 \mu\text{A}$ RMS up to 100 kHz (500 mA model S-4, typical)
- Compliance voltage is adjustable, 10 to 20 V (NOTE: The unit will only deliver the voltage that the load requires, up to the compliance voltage limit.)
- Analog modulation up to 2-3 MHz
- Analog modulation input between -5V and +5V
- Constant Current Mode operation
- Touchscreen with intuitive user interface
- CE compliant, compatible with CDRH laser regulations
- Feature-rich for research projects
 - » USB and Ethernet interfaces with software included
 - » Auto voltage/current scan function
 - » Data collection using a computer or USB flash drive
 - » Field upgradeable firmware
 - » Sophisticated error handling
 - » Save and recall functions for specific set ups
- Rack mountable: 2 U height and 1/2 rack width
- Safety features protect your QCL investment
 - » Adjustable soft-clamp current limit, with Brick-Wall Never-Exceed circuitry
 - » Password protection available to lock out a selectable control set
 - » Keyswitch, active, and passive interlocks
 - » Brown-out & overvoltage protection
 - » Power supply overcurrent protection
 - » Driver over-temperature protection circuit
 - » Relay shorts output when current is disabled
 - » AC input and patented power supply filtering
 - » 2 second turn-on delay — adjustable
 - » 1.5 msec current ramp

THE LOWEST-NOISE DRIVER AVAILABLE

These low noise QCL instruments have the lowest current noise density of any commercially available. Powering your QCL with this patented¹ driver gives you narrow linewidth, stable center wavelength, and repeatable scans.

INTUITIVE USER INTERFACE AND SUPERIOR SOFTWARE CONTROL

With the plug and play instrument, you have the ability to quickly set the controls using either the instrument or a remote computer.

PROTECT YOUR QCL INVESTMENT

All the essential control and monitor functions you expect in a laser driver are incorporated into this instrument, along with protection circuitry to safeguard your QCL from minor power source faults, over-temperature conditions, and electrical faults.

The soft-clamping current limit can be set without enabling the driver output, and uses a brick-wall never-exceed limit circuit to protect the QCL from potentially damaging overcurrent situations.

APPLICATIONS



Due to their unique construction, QCLs operate with high power in the near-IR through terahertz ranges. These wavelengths are particularly suited to detection of molecules significant to humans.

Applications for the lower noise QCL driver include: remote detection of explosive materials, medical diagnosis using the breath, non-invasive glucose testing, emissions monitoring of the atmosphere or marine environments, and pharmaceutical process quality control. Additional applications include anesthesia and hospital air quality monitoring, leak detection, and remote imaging.

¹Covered by U.S. Patents 6,696,887; 6,867,644 and 7,176,755. Licensed from Battelle Memorial Institute

SAFETY

DEFINITIONS

	CHASSIS GROUND Symbol
	CAUTION: A condition that has the potential to cause damage to property or instrument.
	WARNING: A condition that has the potential to cause bodily harm or death.

GENERAL

- Observe all Cautions and Warnings both in the User Guide and on the instrument.
- Use the QCL instrument as specified in this guide or the protection provided by this instrument may be impaired and the warranty will be voided.
- Use good laser safety practices when using the QCL instrument.
- Before proceeding, it is critical that you take precautions to prevent electrostatic discharge (ESD) damage to your laser.
- Locking the instrument with the keyswitch disables the output current. The key can only be removed when in the LOCK position.



POWER CORDS

- This equipment is grounded through the AC power cord grounding conductor.
- Use only the earth-grounded power cords that are recommended in this user guide.
- Route power cords and other cables so that they cannot be damaged.
- Position the QCL instrument in a location that makes it easy to quickly disconnect the power cord.
- To avoid fire hazard, use only the specified power cords with the correct grounding, voltage, and current ratings.



FUSES

- Disconnect the power to the QCL instrument before changing the fuses.
- To prevent damage to the QCL instrument when replacing fuses, locate and correct the problem that caused the fuse to blow before re-applying power.
- To avoid fire hazard, use only the specified fuse with the correct type number, voltage, and current ratings, and use only the recommended replacement parts.

CAUTIONS

	The QCL instrument has no user-serviceable parts. Other than the fuses, the QCL instrument is not designed to be maintained by the user nor does it contain any parts that can be repaired by the user. All maintenance and repairs must be performed by Alpes Lasers or the warranty will be void.
	Use a soft cloth to remove dust from the QCL instrument. Do not expose the QCL instrument to any liquids, sprays, or solvents. To avoid electrical shock, unplug the power cord before cleaning the instrument.
	Before connecting to the power source, make sure the correct cables and voltage for your area are set. The voltage selection is available on the back of the instrument. See the Quick Start Guide for instructions on changing the voltage.

WARNINGS

	Position the QCL instrument so that access to the Main Power On/Off switch on the back panel is easily accessed.
	Do not use the QCL instrument if there is evidence of damage from shipping; damaged equipment can present significant safety hazards. If you suspect the QCL instrument is damaged, contact technical support before attempting to operate the instrument.
	To avoid electrical shock, use the recommended earth-grounded power cables and properly earth-grounded, 3-prong receptacles only. Failure to follow this precaution can result in severe injury.

QUICK CONNECT GUIDE

INSTALL FUSE & SELECT VOLTAGE

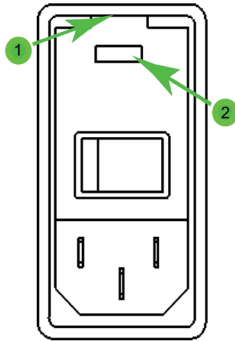

Figure 1. Fuse Box and Voltage Selector

1. On the back panel, locate the Fuse Box and Voltage Selector receptacle. (See the Rear Panel diagram on **page 10** for the location.)
2. Insert a small flathead screwdriver into the slot (1) at the top of the receptacle and twist to open faceplate. The red fuse drawer and fuses are located in the Ship Kit.
3. On the face of the fuse drawer are two voltage choices. Based on your country, select the proper fuses to install.

VOLTAGE	FUSE	PART NUMBER
100-120 V	1.25 A, 250 V, fast blow	Littelfuse 5 x 20 mm, Part #02351.25HXP
220-240 V	0.63 A, 250 V, fast blow	Littelfuse 5 x 20 mm, Part #0217.630MXP



CAUTION: It is imperative that the correct voltage is used. Serious damage can occur if the incorrect voltage is selected.

4. Insert the fuses as shown in **Figure 2**, with a short fuse at the contact end of the receptacle. Then, turn the drawer until the correct voltage label is at the top and replace it in the receptacle. Press firmly to make sure the drawer is completely seated. It should be flush with the receptacle.

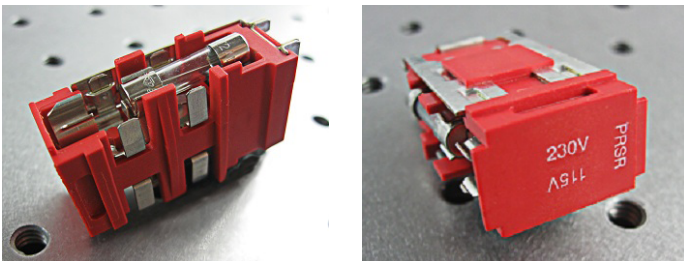

Figure 2. Fuse Installation and Voltage Selector

5. Close the faceplate, again pressing firmly until it is flush. The correct voltage label is shown through the Voltage Window (2) on the faceplate.

WIRE A TEST LOAD

Use of a test load is recommended for setup of the QCL instrument. Use the test loads listed on page 1, or when building your own test load, a 10 Ω resistor with a 50 W power rating is recommended for the 500 mA, 1 A, and 1.5 A models. For the 2 A model, a 50 W 5 Ω resistor is recommended.

- Install the test load by either connecting to the QCL SMA port or wiring the load to PIN 5 and PIN 9 on the QCL D-SUB as shown in **Figure 3**.

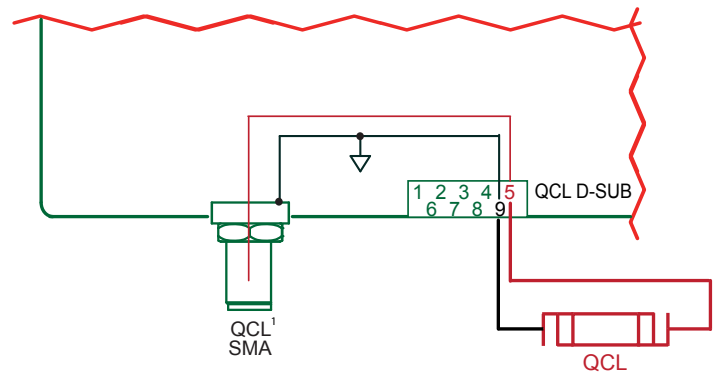

¹NOTE: The SMA case is electrically connected to the QCL chassis.

Figure 3. QCL Wiring Diagram

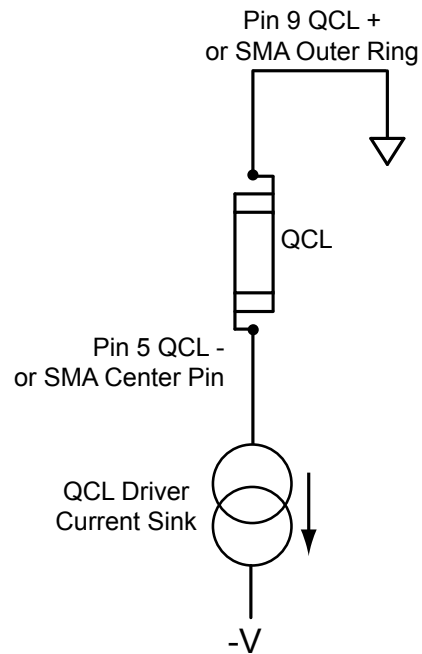

Figure 4. QCL Polarity Diagram

SETUP INTERLOCKS

The Interlock Replacement Kit includes a male D-SUB with the passive interlock pins shorted and a BNC terminator.

1. For the passive interlock, on the back panel, short PIN 1 and PIN 2 on the QCL D-SUB.
2. For the active interlock, on the back panel, insert a BNC terminator in the ACTIVE LOCK BNC port.
3. On the front panel, the keyswitch must be on UNLOCK to enable the current to the QCL.

TURN ON POWER

1. On the back panel, press the power switch to the |. The front panel power button light pulses slowly.
2. On the front panel, press the Power button. The button illuminates, the touchscreen activates, and the Control screen is active.
3. The front panel displays dashes instead of digits until the unit has finished its power-up sequence (~10 seconds).

SET LIMITS



1. Press to access the Limit Screen.

2. On the Limit screen, press the blue Limit Current value and rotate the Adjustment knob to change to the desired value. The instrument will beep when set.

NOTE: The Max Supply Voltage and Cable Resistance values can be ignored for now.

ADJUST SETPOINT



1. Press to access the Control Screen.

2. Press the Setpoint current value and turn the Adjustment knob to change it. The instrument will beep when set.

ENABLE CURRENT

Press the ENABLE button. There is a standard 2-second delay before the button illuminates and the current flows.

SHUTDOWN THE INSTRUMENT

If the Enable button is illuminated, current is still flowing to the test load. Before shutting down, the current needs to be turned off.

1. Press the Enable button. The button light will turn off and current to the QCL test load will stop.
2. On the front panel, press the Power button. The touchscreen will go black but the button light slowly pulses blue to indicate that the back Power button is still on. NOTE: Turning off only the front Power button puts the instrument in Standby mode.
3. On the back panel, press the power switch to O.

PIN DESCRIPTIONS

QCL D-SUB

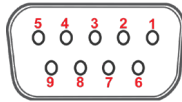

Figure 5. Female 9-Pin D-SUB

MONITOR D-SUB

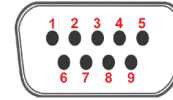

Figure 8. Male 9-Pin D-SUB

Table 1. QCL D-SUB Pin-Out

PIN	DESCRIPTION
1, 2	Passive interlock pins (must be shorted to enable current)
3	Chassis ground
4	Not used
5 *	QCL- (negative)
6	Not used
7	Not used
8	Not used
9 *	QCL+ (positive)
SHELL	Chassis ground

* NOTE: Use Pins 5 and 9 for current to the QCL.

Table 2. Monitor D-SUB Pin-Out

PIN	DESCRIPTION
1	Alignment LED (+5 V) can source 250 mA
2	Alignment LED ground
3	QCL current enabled indicator (+5 V TTL) high = disabled low, ground = enabled
4	QCL current enabled indicator ground
5	Not used
6	Analog setpoint monitor
7	Analog monitor ground
8	Analog output current monitor
9	Analog monitor ground

QCL SMA

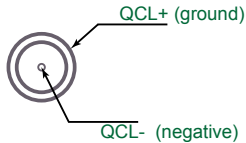

Figure 6. SMA Pin-Out

BNC PINS

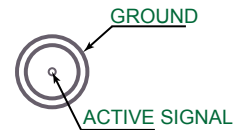

Figure 9. BNC Pins

QCL POLARITY

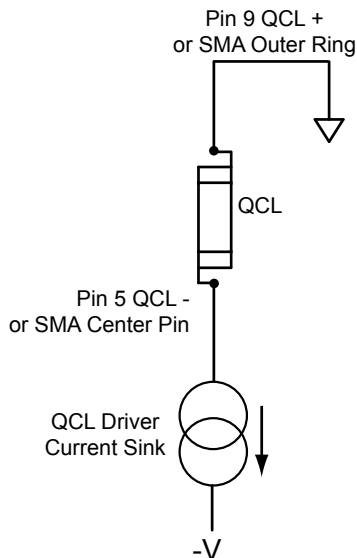

Figure 7. QCL Polarity Diagram

TRANSFER FUNCTIONS BY MODEL

External modulation input, setpoint monitor, and analog current monitor transfer functions:

500 mA model:	0.1 A / V.
1.0 A model:	0.2 A / V.
1.5 A model:	0.3 A / V.
2.0 A model:	0.4 A / V.

The input range is always -5 V to +5 V.

ACTIVE INTERLOCK BNC

Ground the center pin to the outer shell to override the interlock and allow the current to flow to the QCL. If an external circuit won't be used, a 50 Ω or 75 Ω terminator is acceptable.

TRIGGER BNC

See Additional Capabilities on [page 16](#).

ELECTRICAL SPECIFICATIONS

DRIVER OUTPUT CURRENT	MIN	TYP	MAX	UNITS	NOTES
Output Current	0.5, 1.0, 1.5, or 2.0			A	
RMS Noise Current	0.4	1.0	1.3	μA RMS	1 A model at 500 mA output, 100 kHz test bandwidth
Noise Current Density	1	2	4	nA / √Hz	1 A model at 500 mA, 10 Ω test load
Stability, short and long term	5	10	15	ppm	25°C ambient
Temperature Coefficient	5	10	18	ppm / °C	
Compliance Voltage Range	10		20	V	Internal Supply Voltage can be adjusted from the front panel. NOTE: With this current source, the voltage developed across the load (laser) is not driven by the controller, but by Ohm's Law and the resistance of the load (laser).
Slow Start Current Ramp (after Enabled)	1.5			msec	To setpoint
Delayed Start	2			sec	User adjustable

EXTERNAL MODULATION	MIN	TYP	MAX	UNITS	NOTES
Modulation Bandwidth		2	3	MHz	Sinewave
Rise/Fall Time	250 / 200			nsec	To full scale
Slew Rate		30		V / μsec	
Depth of Modulation		90		%	At 500 kHz
External Modulation Input Range	-5 to +5			V	
Input Impedance		1		kΩ	
External Modulation Input Damage Threshold	-10 to +10			V	BNC Connector

MONITORS AND OUTPUTS	VALUE	UNIT	NOTES
Setpoint Resolution	16	bits	5V = fullscale output
Display Accuracy Measurement Resolution	24	Bits	
Accuracy, Current Output Monitor vs. Actual Current (display or analog output)	0.2	%	> 5% of full scale
	0.5	%	< 5% of full scale
Accuracy, Current Setpoint vs. Actual Current	0.2	%	Internal setpoint
	0.2	%	External modulation
Accuracy, Analog Setpoint Monitor ¹	5	%	>10% of full scale
	25	%	<10% of full scale

¹ Current Setpoint Monitor is a reference signal only, and may deviate from the actual setpoint by up to 5% when the setpoint is greater than 10% of full scale.

CONTINUED ON FOLLOWING PAGE

POWER SUPPLY REQUIREMENTS	VALUE	NOTES
AC Power Supply and Line Frequency	100-120 / 220-240 VAC, 2 A, 50-60 Hz	Switch selectable: 100-120 V and 220-240 V, appropriate power cord supplied
Fuse for 220-240 V	0.63 A, 250 V, fast blow	5 × 20 mm, Part #0217.630MXP, Littelfuse
Fuse for 100-120 V	1.25 A, 250 V, fast blow	5 × 20 mm, Part #02351.25HXP, Littelfuse
Power Consumption	9.8 Watts	At idle, no output to QCL load

GENERAL SPECIFICATIONS	VALUE	NOTES
Warm-up Time	1 Hour	
Remote Interface	USB, Ethernet	
Warranty	One (1) Year	
Safety Tested To	IEC 61000-3-2 IEC 61000-3-3 IEC 61000-4-2 IEC 61000-4-3 IEC 61000-4-4 IEC 61000-4-5 IEC 61000-4-6 IEC 61000-4-8 IEC 61010-1	European Council Directive 2004/108/EC & European Council Directive 2006/95/EC
	CE Mark	

ABSOLUTE MAXIMUM RATINGS	VALUE	UNIT	NOTES
Case Operating Temperature Range	-40 to 50	°C	
Humidity	80	%	Relative humidity at 30°C (non-condensing)
Weight	12 (~5.4)	lbs (kg)	
Size	3.47 × 8.86 × 17.72 (89 × 226 × 450)	inches ³ (mm ³)	

OPERATING INSTRUCTIONS (STAND-ALONE)

WHAT'S IN THE BOX

- QCL Instrument
- Power Cable, type appropriate for final location
- Red fuse tray
- Two 0.63 A fuses and two 1.25 A fuses for fuse box on the back panel
- USB Flash Drive, includes all necessary software, instrument documentation, and additional storage space
- Keys for the keyswitch
- Interlock Replacement Kit (interlocks for QCL D-SUB and Active Interlock BNC)

THEORY OF OPERATION

The S – 4 Series low noise QCL drivers are designed expressly to drive quantum cascade lasers, and utilize patented¹ circuitry to deliver ultra-low noise current and still maintain a wide modulation bandwidth.

The QCL drivers are controlled current sources; they deliver the current commanded by the setpoint. The current source continually monitors the actual output current, compares it to the setpoint, and adjusts the current if there is a difference between the two signals.

As current is driven through the load, there is a voltage drop across the load proportional to the load resistance and current. As the current increases, the voltage drop may increase to the point that it reaches the Compliance Voltage limit of the current source. Once that occurs the current source is no longer able to increase the current driven to the load even if you increase the setpoint.

The QCL driver includes features that help protect your laser, and also make the driver more versatile in a wide array of applications. These features are explained in detail in the Operating Instructions.

- The user-adjustable current limit prevents overdriving the laser even if the external modulation signal is above the maximum drive current for the laser.
- Over- and under-voltage protection circuits protect the driver and QCL if the power supply voltages fall outside of the acceptable operating range.
- Over-temperature protection circuits safely shut down the output if the internal temperature of the QCL driver rises to an unsafe level. The fan turns on to manage the internal temperature.
- Output slow-start ramps the current to setpoint over 1.5 msec.
- A mechanical relay shorts the output connections when the output is disabled, and when the QCL driver is powered off.

The External Modulation Input can be used for adding to or subtracting from the internal setpoint on the QCL LAB Instrument. Inputting positive voltages will result in adding to the setpoint, while inputting negative voltages will result in subtracting from the setpoint.

These instructions are for operating the QCL Laboratory Series instrument. Fuses are provided but not installed. After installing the fuses in the fuse box, be sure to install the fuse box so the correct voltage for your country is showing. We also recommend using a test load until you are familiar with operation of the instrument.

REQUIRED AND OPTIONAL EQUIPMENT

FOR SET UP

- Small, narrow headed flathead screwdriver (required)
- Test load (optional)
- Interlock Replacement Kit with interlock overrides (optional)

COMPUTER REQUIREMENTS FOR REMOTE OPERATION ONLY (OPTIONAL)

Operating System: Windows XP SP2 or later

Note: See **page 16** for Remote Operation

ESD INFORMATION

Before proceeding, it is critical that you take precautions to prevent electrostatic discharge (ESD) damage to the load. ESD damage can result from improper handling of sensitive electronics, and is easily preventable with simple precautions.

¹Covered by U.S. Patents 6,696,887; 6,867,644 and 7,176,755. Licensed from Battelle Memorial Institute.

REAR PANEL

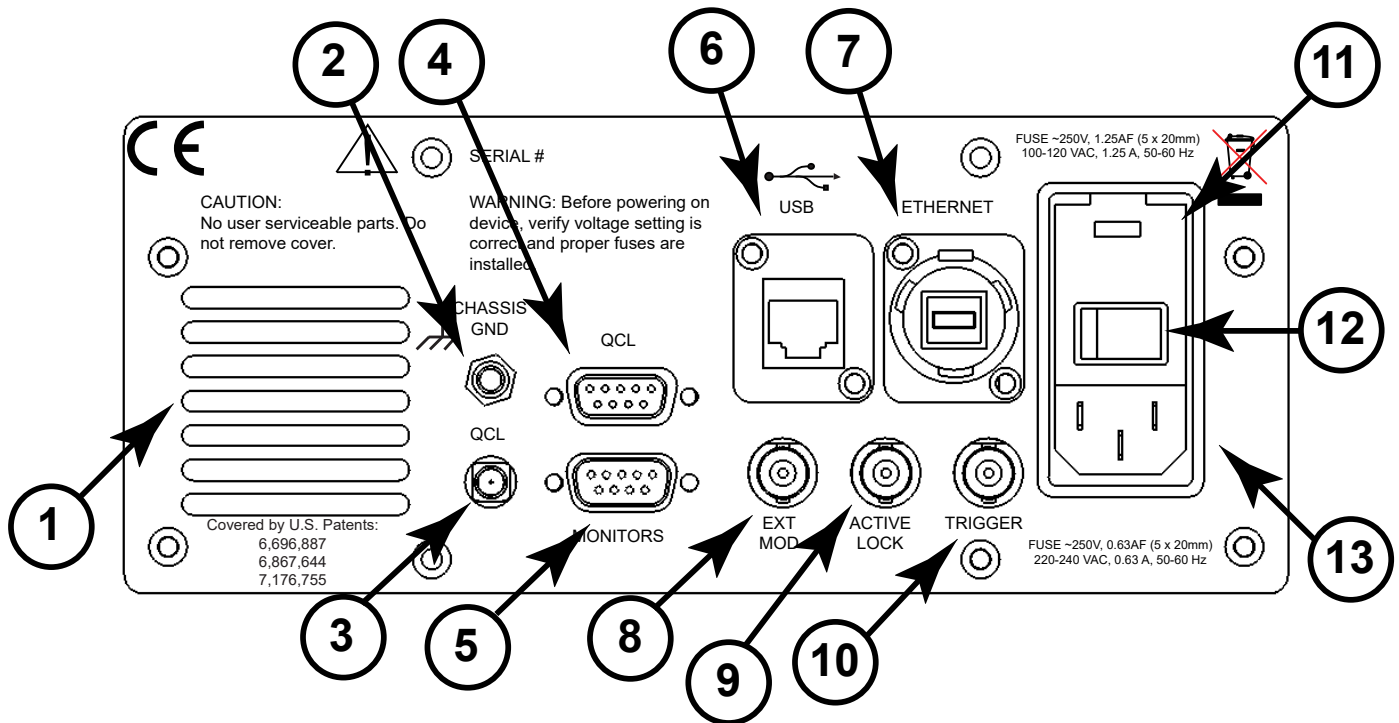

Figure 10. Rear Panel

Table 3. Rear Panel Functions

	NAME	DESCRIPTION
1	Fan Vent	Do not block air flow.
2	Chassis Ground	Physical connection to chassis and electrical earth ground.
3	QCL SMA	SMA connector, alternate connection to QCL.
4	QCL D-SUB	9-Pin female D-SUB connector.
5	Monitors	9-Pin male D-SUB connector.
6	USB	USB port, connection between instrument and a computer.
7	Ethernet	Ethernet port, connection between instrument and a computer or network.
8	EXT MOD	External Modulation: BNC connector, setpoint signal generator input.
9	Active Lock	BNC connector, active interlock, tie center pin to GND to enable output.
10	Trigger	BNC connector output, allows instrument to trigger external device for synchronizing measurement.
11	Fuse Box and Voltage Selector	Removable fuse drawer allows user to switch between 115 V and 230 V. Fuses need to be installed prior to operation.
12	Power Switch	AC power switch that powers the instrument.
13	Power Plug	IEC AC line input.

INSTALL FUSES AND SELECT PROPER VOLTAGE

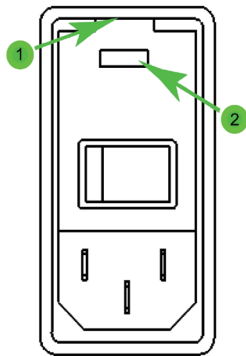

Figure 11. Fuse Box and Voltage Selector

1. On the back panel, locate the Fuse Box and Voltage Selector receptacle. (See the Rear Panel diagram on **page 10** for the location.)
2. Insert a small flathead screwdriver into the slot (1) at the top of the receptacle and twist to open faceplate. The red fuse drawer and fuses are located in the Ship Kit.
3. On the face of the fuse drawer are two voltage choices. Based on your country, select the proper fuses to install.

VOLTAGE	FUSE	PART NUMBER
100-120 V	1.25 A, 250 V, fast blow	Littelfuse 5 x 20 mm, Part #02351.25HXP
220-240 V	0.63 A, 250 V, fast blow	Littelfuse 5 x 20 mm, Part #0217.630MXP



CAUTION: It is imperative that the correct voltage is used. Serious damage can occur if the incorrect voltage is selected.

4. Insert the fuses as shown in **Figure 12**, with a short fuse at the contact end of the receptacle. Then, turn the drawer until the correct voltage label is at the top and replace it in the receptacle. Press firmly to make sure the drawer is completely seated. It should be flush with the receptacle.

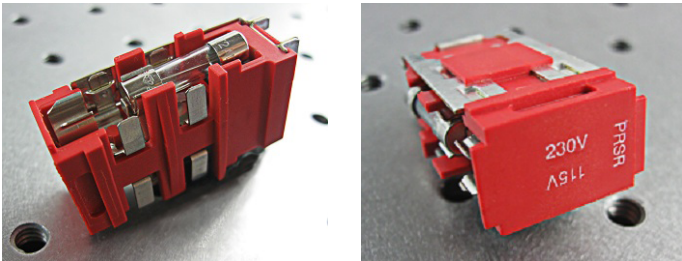

Figure 12. Fuse Installation and Voltage Selector

5. Close the faceplate, again pressing firmly until it is flush. The correct voltage label is shown through the Voltage Window (2) on the faceplate.

CONNECT POWER

Insert the female end of the IEC AC power cord into the Power receptacle on the back panel and then plug the male end into the power source.

WIRE A TEST LOAD

Use of a test load is recommended for setup of the QCL instrument. Use the test loads listed on page 1, or when building your own test load, a 10 Ω resistor with a 50 W power rating is recommended for the 500 mA, 1 A, and 1.5 A models. For the 2 A model, a 50 W 5 Ω resistor is recommended.

- Install the test load by either connecting to the QCL SMA port or wiring the load to PIN 5 and PIN 9 on the QCL D-SUB as shown in **Figure 13**.

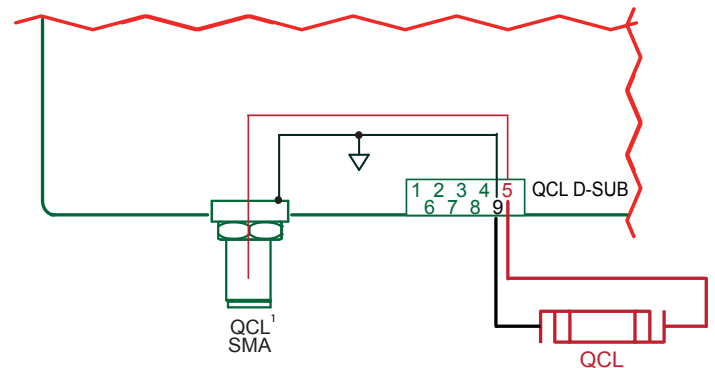

¹NOTE: The SMA case is electrically connected to the QCL chassis.

Figure 13. QCL Wiring Diagram

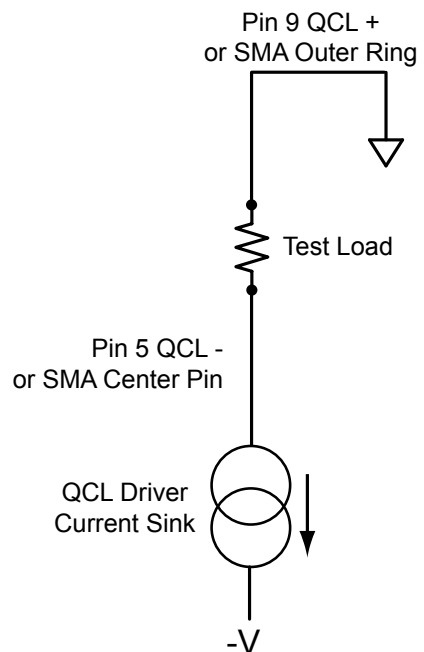

Figure 14. Test Load Polarity Diagram

SET UP INTERLOCKS

The Interlock Replacement Kit includes a male D-SUB with the passive interlock pins shorted and a BNC terminator.

1. For the passive interlock, on the back panel, short PIN 1 and PIN 2 on the QCL D-SUB.
2. For the active interlock, on the back panel, insert a BNC terminator in the ACTIVE LOCK BNC port.
3. On the front panel, the keyswitch must be on UNLOCK to enable the current to the QCL.

NOTE: To disable operation, turn the keyswitch to the LOCKED position. The key can only be removed when in the locked position.

TEXT AND ICON COLOR KEY

TEXT

Text indicates current state.

White, Green Uneditable field, for information only.

Blue Editable field, touch to select or toggle field (text highlights and changes color), adjust using either the touchscreen or adjustment knob. Instrument beeps and text returns to blue when values are set. Touch again to cancel selection.

ICONS

Icon color indicates current state.

Blue Screen is active.

Grey Screen is inactive, touch icon to access that screen.

FRONT PANEL

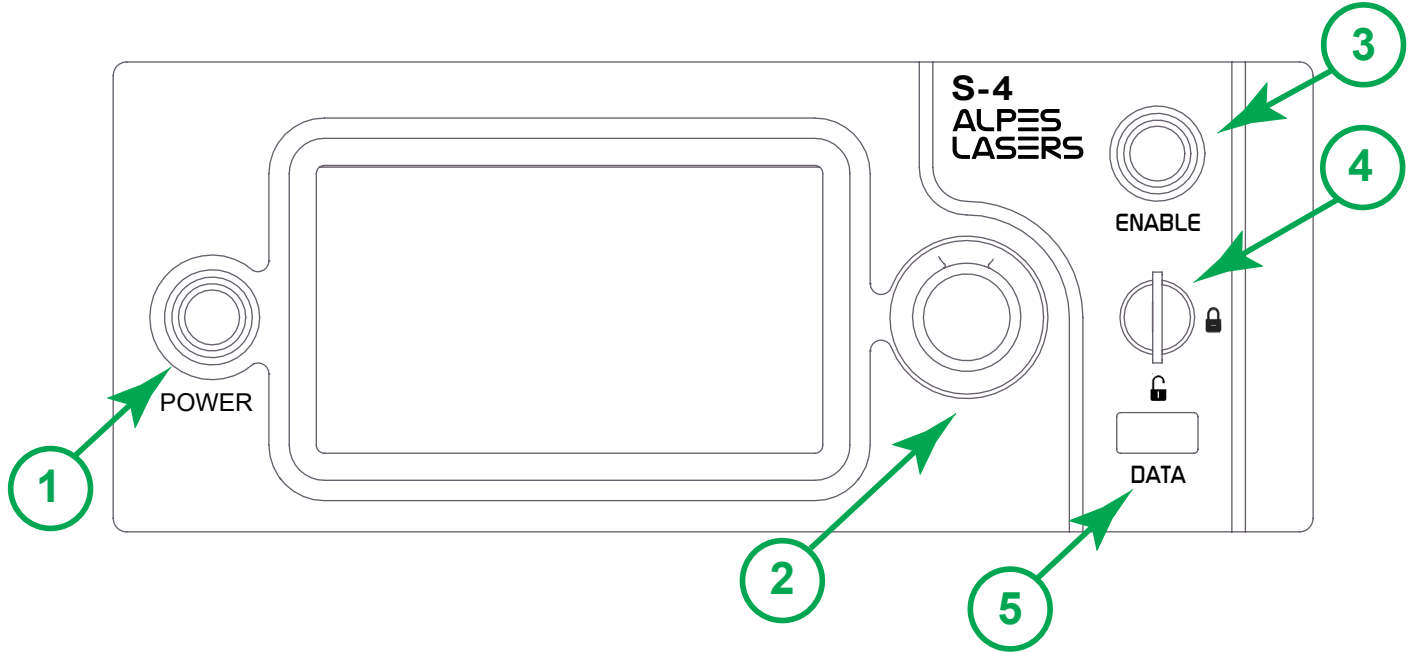

Figure 15. Front Panel

Table 4. Front Panel Functions

	NAME	DESCRIPTION
1	Power Button	Powers the application electronics. Glows blue when application electronics power is on and unit is operational, slow pulses blue when on Standby and only the back panel power switch is on.
2	Adjustment Knob	Turn to adjust the numeric values. Instrument beeps when values are set.
3	Enable Button	Allows instrument to deliver current to the QCL. Glows blue when current is enabled.
4	Keylock Switch	UNLOCK allows laser output current to flow, LOCK disables laser output current. NOTE: The key can be removed only in LOCK position.
5	Data Port	USB flash drive, used to update the firmware or save data. This is not used for remote USB control of the instrument.

TURN ON QCL INSTRUMENT

1. Press the **Power** switch on the back panel to |. The front panel power button light slowly pulses.
2. Press the **Power** button on the front panel, the button illuminates, touchscreen is activated, and the Control screen is active.

NOTE: Turning off front **Power** button powers down the application electronics and puts the unit into standby mode. Turning off rear **Power** switch powers down all electronics and settings return to factory default.

3. The front panel displays dashes instead of digits until the unit has finished its power-up sequence (~10 seconds).

SET LIMITS



1. Press to access the Limit Screen.

2. Press **Limit Current**, **Maximum Supply Voltage**, and/or **Cable Resistance** values and rotate the Adjustment knob to change each value. The instrument will beep when set.

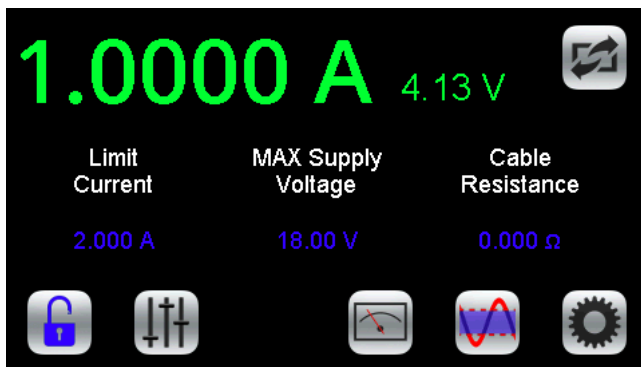

Figure 16. Limit Screen

NOTES:

- The **Limit Current** should not exceed the damage current threshold of your QCL.
- The **Maximum Internal Supply Voltage** can be lowered to minimize internal instrument temperature or to act as a compliance voltage clamp on the QCL output current. See Additional Technical Notes on **page 20** for optimization instructions.
- The **Cable Resistance** range is 0 – 4 Ω.

QCL Voltage displays the voltage at the QCL DSUB or SMA terminals. To account for voltage loss across the cable to the QCL, you can enter a non-zero value for **Cable Resistance**.

The QCL Voltage will now display as:

Voltage Displayed = Voltage@Pins - (Cable Resistance x Operating Current)

- The minimum limit current is about 8% of full scale.

ADJUST THE SETPOINT



1. Press to access the Control Screen.
2. Press the **Setpoint** value and turn the **Adjustment** knob until the desired operating current is displayed.

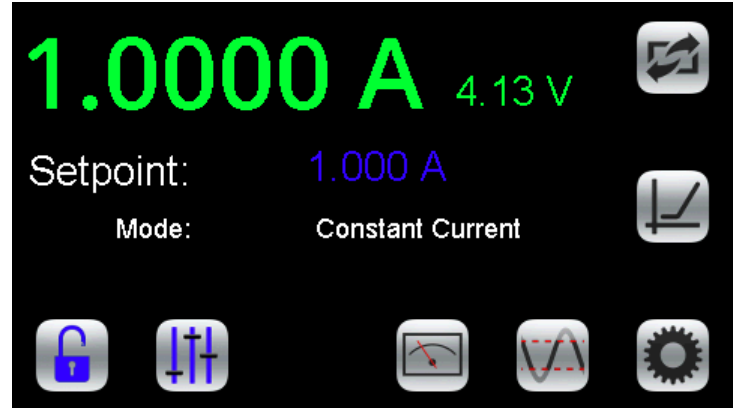

Figure 17. Control Screen

NOTE: The Control screen is on by default when the instrument is turned on. The Mode is Constant Current by default and cannot be changed.

DISPLAY EXISTING CURRENT AND VOLTAGE VALUES



Press to access the Monitor Screen.

Values on this screen cannot be changed and are for information only.

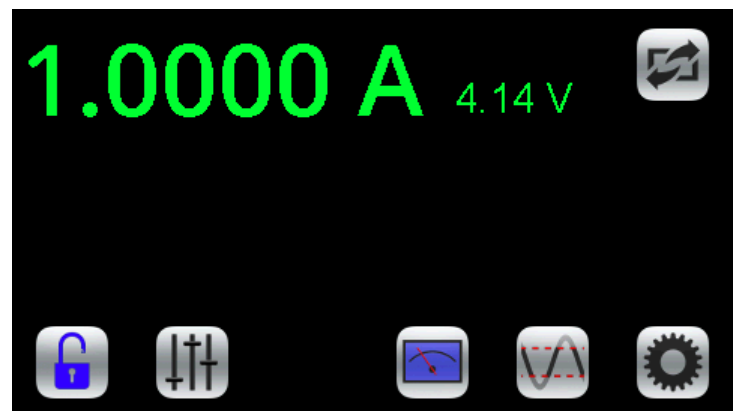

Figure 18. Monitor Screen

ENABLE THE QCL INSTRUMENT

Press the **Enable** button on the front panel. The button will glow blue only when current is delivered to the load. There is a standard 2-second delay before the button illuminates and current flows.

VI SCAN



1. On the Control screen, press to access the VI scan screen.

2. Press the **Current Start** value to select the current at which to start the scan. Turn the **Adjustment** knob to change it.

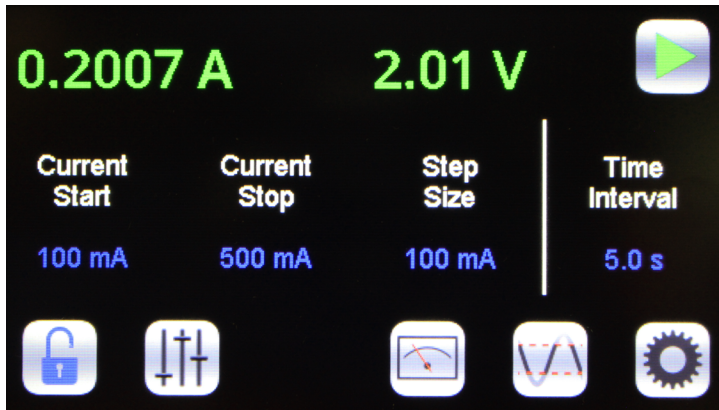

Figure 19. Scan Screen

3. Press the **Current Stop** value to select the current at which to stop the scan.
4. Press the **Step Size** value to select the current interval at which to take a measurement. The maximum interval is 10% of full scale. Minimum step is 1% of full scale.
5. Press the **Time Interval** value to select the amount of time to allow the current to settle. For the best data accuracy, use a Time Interval of 2 seconds or more. The minimum time interval is 0.1 seconds.
6. Insert the USB flash drive in the USB slot on the front panel.
7. Press the green **Run** button to start the scan. When finished, data is saved to the USB flash drive with the filename *viscanxx.txt*, where *xx* starts at 00 and increments.
8. To stop mid-scan, press the red **Stop** button to abort the scan. Any data collected during the aborted scan is saved to the USB flash drive.

NOTES:

- The step interval time is approximate. In the scan files, time intervals are slightly more than the step interval indicated on the instrument. Each interval builds on the previous one.
- Should the Step Size interval not finish at the Stop Current, the reading is still taken and recorded. For example, if the Start Current is 250 mA and the Stop Current is 1.04 A with a Current Step of 250 mA, a reading is taken at 1000 mA (1 A) and 1040 mA (1.04 A) but not at 1250 mA (1.25 A).
- After a VI scan is completed, the output is disabled and the setpoint is zeroed.

SAVE OR RECALL SETTINGS



Press to access the Save/Recall Screen.



Under **Save Settings to**, press the blue text to toggle through the Profile options, select one, and then press the **Save** icon.

The following variables are saved:

OPERATION SETTINGS	VI SCAN SETTINGS
Setpoint	VI Start Current
Current Limit	VI Stop Current
Max Supply Voltage	VI Step Size
Cable Resistance	VI Time Interval
Display Brightness	
Beeper Status	

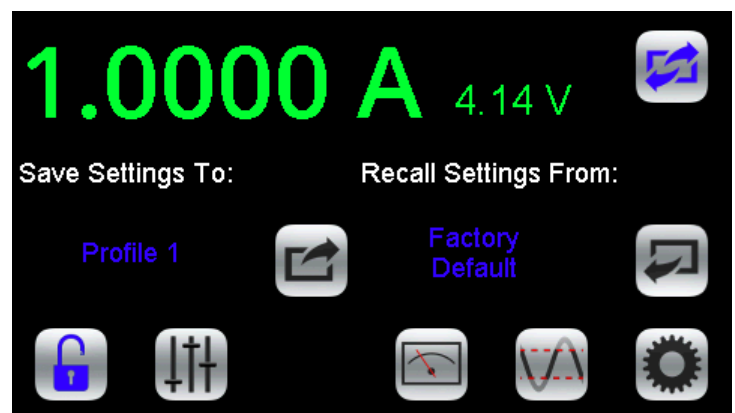

Figure 20. Save / Recall Screen



Under **Recall Settings from**, press the blue text to toggle through the saved Profile options, and then press the **Recall** icon to recall the saved settings. Select **Factory** to restore the settings to the factory defaults.

SETTINGS SCREEN



Press to access the Settings Screen

Move the slider bar on the touchscreen to change the display brightness. Press the blue text to toggle the **Beeper** on-off setting.

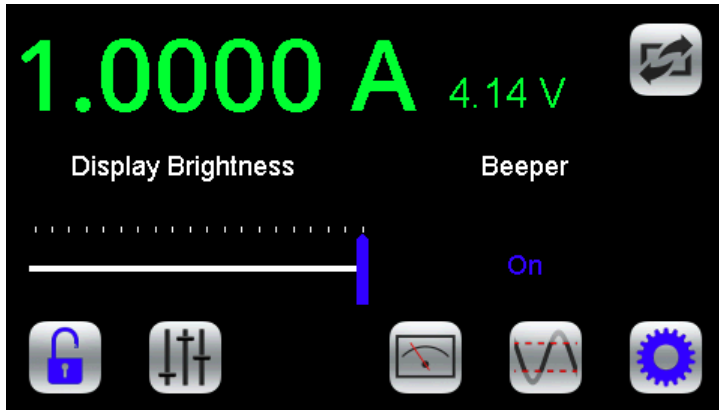

Figure 21. Settings Screen

LOCK OR UNLOCK SETTINGS (OPTIONAL)



Settings are not locked.

This is the default. Critical values set with the Adjustment knob can be locked. Press to lock the settings.



Settings are locked.

Press to unlock the settings.



Settings are locked and password protected.

Locked settings that are password protected can only be locked and unlocked using a remote computer.

EXTERNAL MODULATION (EXT MOD) BNC

This is the external modulation input. The voltage input on this BNC sums with the DC value on the screen. The input impedance is 1 k Ω . To calculate the external modulation signal voltage, see the next section for the transfer function, and use the following equation:

$$V_{\text{EXT_MOD}} = I_{\text{SETPOINT}} / \text{Transfer Function}$$

If the external modulation input causes the driver to reach the current limit, the output signal will be clamped at the limit level but will not switch off.

The bandwidth of the Current Monitor is lower than the bandwidth of the output. To monitor the actual output waveform at high frequencies, connect an oscilloscope across the output pin on the MONITOR D-SUB, Pin 8 (positive), and Pin 9 (ground) while using the resistor test load.



CAUTION: Connect the oscilloscope across the test load only — never connect the oscilloscope across a quantum cascade laser.

EXTERNAL MODULATION BNC TRANSFER FUNCTIONS

The external modulation transfer function depends on the QCL instrument model and is as follows:

500 mA model:	0.1 A / V.
1 A model:	0.2 A / V.
1.5 A model:	0.3 A / V.
2 A model:	0.4 A / V.

The input range is always -5 V to +5 V.

ADDITIONAL CAPABILITIES

ANALOG CURRENT MONITOR

This signal is the sum of the DC setpoint as shown on the screen and the external modulation input.

To monitor the analog current level:

1. Connect the Analog output Current Monitor (PIN 8) on the MONITOR D-SUB to an oscilloscope.
2. Connect an Analog Monitor Ground (PIN 7 or PIN 9) to oscilloscope ground.

SETPOINT CURRENT MONITOR

This is a reference only and can be off by as much as 5% when setpoint is >10% of full scale.

To monitor the setpoint current:

1. Measure the voltage on the Analog Setpoint Monitor (PIN 6).
2. Ground for that measurement is the Analog Monitor Ground (PIN 7 or PIN 9).

The setpoint monitor and analog current monitor transfer functions depend on the QCL instrument model and are all as follows:

500 mA model:	0.1 A / V.
1 A model:	0.2 A / V.
1.5 A model:	0.3 A / V.
2 A model:	0.4 A / V.

The input range is always 0 – 5 V.

ALIGNMENT LED DRIVE

+5 V, up to 250 mA sourced.

To drive an alignment LED, on the MONITOR D-SUB

1. Connect an LED to the Alignment LED +5V (PIN 1).
2. Ground the LED at the Alignment LED Ground (PIN 2).

ENABLE STATUS INDICATOR

This is a +5 V TTL indicator. If current to the QCL output is enabled, the voltage between PIN 3 and PIN 4 on the MONITORS D-SUB will be low. It will be high if current is disabled.

USE THE TRIGGER SIGNAL

A trigger signal is provided so that external measurement equipment can be synchronized with laser current. Exactly 10 msec after a remote change in setpoint, a 20 μ sec positive going pulse appears on the Trigger BNC plug.

To use the Trigger, connect a BNC cable to the TRIGGER BNC output.

REMOTE OPERATING INSTRUCTIONS

INSTALL THE QCL LABVIEW INTERFACE APPLICATION

Contact Alpes Lasers for LABView application.

USE REMOTE COMMANDS AND NATIONAL INSTRUMENTS DAQ CARD

Contact Alpes Lasers for Remote Commands information.

TROUBLESHOOTING

Table 5. Troubleshooting

PROBLEM	POTENTIAL CAUSES	SOLUTIONS
Front panel Power button does not turn on	The button has been pushed on and off within 3 seconds.	The front panel Power button has a 3 second delay between when it is turned off and on in rapid succession. This is a safety mechanism to ensure there is no damage to either the QCL instrument or the attached load.
	The rear panel switch is off.	Turn the rear panel switch to the on or position.
The Enable button does not turn on	The button has been turned on and off within 2 seconds.	The button cannot be pressed faster than every 2 seconds.
	The QCL D-SUB interlock or Active Interlock connections are open, or the keyswitch is in the LOCKED position	<ul style="list-style-type: none"> Make sure PIN 1 and PIN 2 on the QCL D-SUB are shorted. The “Active Lock” BNC connector may be open. Install a BNC shorting plug. Rotate the key to the UNLOCKED position.
	The instrument experienced an internal fault. (See Error Messages on page 19.)	The instrument will remain disabled until manually powered off and then on using the rear panel power switch.
	The instrument heatsink temperature has exceeded 70°C.	Allow the instrument to cool down and then press the front panel power button.
	The front panel Power button is not on.	Press the Power button on the front panel to enable the display.
The instrument is on but the front panel display is blank	The instrument experienced an internal fault. (See Error Messages on page 19.)	Switch the back panel power button off and then on again, and turn the front panel power button on.
	The internal temperature has reached an unsafe level.	Allow the instrument to cool down and then switch the back panel power button off and then on again, and turn the front panel power button on.
	The front panel Power button is pulsing on and off in standby mode.	Press the Power button on the front panel to enable the display.
The date and time on my VI scan file are wrong		The QCL instrument does not have a realtime clock. When a VI scan file is created, the date and time stamp are randomly chosen.
The VI scan files are not in the order that they were created	Some files may have been deleted off of the USB flash drive.	When files are deleted off of the USB flash drive and new files are saved to it, the new files are given sequentially the names of the deleted files.
Unable to create new VI scans	The interlocks may not be satisfied.	Turn the keyswitch to UNLOCKED, or install the ACTIVE LOCK BNC and passive interlocks.
	There are too many files on the USB flash drive.	Delete files from the USB flash drive.
I can't find my VI scan files	VI scan files are named sequentially.	If files have been deleted from the flash drive, any new files added are named sequentially and have the names of the deleted files.
The fan keeps coming on	The internal temperature is being regulated.	To reduce internal heat generation, choose a lower supply voltage. The instrument will shut down if the internal temperature gets too hot.

PROBLEM	POTENTIAL CAUSES	SOLUTIONS
Noise current is higher than expected.	There may be ground loops in the system; some system components may be higher noise than expected; cabling and shielding may be inadequate.	More shielding may be required, and cables may be too long.
The output switched off unexpectedly	The instrument detected an internal error. (See Error Messages on page 19 .)	Switch the back panel power button off and then on again, and turn the front panel power button on.
	The internal temperature has exceeded 70°C.	Allow the instrument to cool down and then press the front panel power button.
20 kHz noise is in the output current	QCL driver is operating in current limit.	If safe for the quantum cascade laser, increase the output current limit setting. When actively operating in current limit, the safety circuits add noise to the output.
If I run my QCL at about 5% of maximum output current, the transfer function becomes non-linear and I see distortion in my output current waveform.	QCL driver resolution is too low.	Select a QCL driver with a much lower maximum output current. For example, to run 50 mA, request a QCL125 (125 mA maximum output).
My instrument doesn't show up in the list. (Remote Only)	Your instrument may not be turned on.	Power up the instrument and click Refresh on the Choose Instrument window.
	Your instrument may not be plugged in to the computer.	Check that either a USB or Ethernet cable is tightly connected to the instrument and to the computer.
	Your instrument may be on a different sub-net.	Add the sub-net to the Choose Instrument window and then click Refresh .
Actual current does not match the setpoint.	The setpoint exceeds the limit current setting.	If the limit current can be increased without damage to the QCL, increase the limit current setting.
	The QCL is compliance voltage limited.	Increase the Max Supply Voltage slightly to see if actual current increases. Follow the instructions on page 20 to optimally set the Max Supply Voltage.

ERROR MESSAGES

Table 6. Error Messages

To clear error text, fix the cause then press any icon or the Enable button.

ERROR	POTENTIAL CAUSES	SOLUTION
The USB flash drive is missing or not accessible. Please make sure that a USB flash drive is inserted into the front panel.	To run a local VI scan, a USB flash drive must be in place.	Insert a USB flash drive in the data port on the front panel.
The USB flash drive was removed. The scan has been aborted.	To run a local VI scan, a USB flash drive must be in place.	Insert a USB flash drive in the data port on the front panel.
Output current is disabled. The keyswitch is in the locked position.	The keyswitch is horizontal or in the locked position.	Turn the keyswitch to the vertical or unlocked position.
Output current disabled. Pins 1 & 2 on the QCL D-SUB are not tied.	The passive interlock is not shorted.	Short Pin 1 and Pin 2 on the QCL D-SUB.
Output current disabled. The Active Interlock is not shorted.	The active interlock is not grounded.	Ground the center pin of the Active Lock BNC.
The internal temperature limit of the instrument has been exceeded. Output current has been disabled to protect the laser.	The ambient air temperature is too high for the instrument.	Reduce the ambient air temperature to 50°C or less.
The VI scan was canceled by the user.	The Stop button was pressed during the scan.	
Scan was canceled because output current is disabled.	The Enable button was pressed during a scan, cutting current to the load.	
An open circuit was detected at the load. Please verify the load and load connections.	The instrument cannot drive current through the load.	Make sure the QCL SMA or Pins 5 & 9 of the QCL D-SUB are connected.
A short circuit was detected at the load terminals. Please verify the load and load connections.	The instrument is detecting that there is no resistance where the load should be.	Make sure the QCL SMA or Pins 5 & 9 of the QCL D-SUB are connected.
An internal error occurred while reading data from hardware. Please contact the factory for further assistance.		Contact technical support for further assistance.
A timeout occurred waiting for output. Make sure the load is connected and interlocks are satisfied.		Contact technical support for further assistance.
An internal error was detected. Please contact the factory for further assistance.		Contact technical support for further assistance.
A fault in the internal +5V supply was detected. Please contact the factory.		Contact technical support for further assistance.
A fault in the internal +15V supply was detected. Please contact the factory.		Contact technical support for further assistance.
A fault in the internal -15V supply was detected. Please contact the factory.		Contact technical support for further assistance.
A timeout occurred waiting for the internal load power supply to stabilize. Please contact the factory.		Contact technical support for further assistance.
A problem has been detected in the instrument power supply. Please contact the factory for further assistance.		Contact technical support for further assistance.
A current surge has been detected in the instrument. Output has been disabled to protect the laser.		Contact technical support for further assistance.

ADDITIONAL TECHNICAL NOTES

This section includes useful technical information on these topics:

- Reduce internal temperature or provide compliance voltage limit
- Use Passive and Active interlocks
- Soft-clamp current limit
- Square wave response
- Remove the bail and feet from an instrument
- Update firmware
- Determine firmware version installed

REDUCE INTERNAL TEMPERATURE OR PROVIDE COMPLIANCE VOLTAGE LIMIT

At full current, the Maximum Compliance Voltage available to the QCL is about 7.5 V below the maximum supply voltage. This 7.5 V estimate decreases as operating current decreases. To determine the best internal supply voltage for your application, follow these steps:

1. Wire your QCL to the instrument and adjust the current limit on the Limit screen and setpoint on the Control screen for your application.
2. Press the Enable button to enable the output current. The actual current displayed should match the setpoint.
3. On the Limit screen, select the blue MAX Supply Voltage value and, using the Adjustment knob, adjust it down slowly until the actual current starts to decrease. The QCL current is now limited by the compliance voltage of the instrument.
4. Using the Adjustment knob, now increase the MAX Supply Voltage value until the current is no longer below the setpoint. This is the optimal maximum supply voltage for your setup.
5. On the Monitor screen, observe the QCL Voltage. This is the voltage across the QCL at this operating current and is the effective voltage limit to the QCL for your setup.

NOTE: If you reach 18 V on the MAX Supply Voltage input and the current is still not compliance voltage limited, the instrument is operating at its lowest voltage and the voltage limit cannot be reduced further.

USE PASSIVE AND ACTIVE INTERLOCKS

The passive interlock is designed to trigger if Pins 1 and 2 on the QCL D-SUB are not shorted. Use this interlock with doors and enclosures that trigger an open circuit when opened.

The active interlock (ACTIVE LOCK BNC) can be used with a temperature controller or other active system component to disable the current output if the QCL exceeds an acceptable temperature operating range.

SOFT-CLAMP CURRENT LIMIT

The QCL driver employs a soft-clamping current limit that begins to act at a current lower than the calculated absolute current limit.

The Limit Current is the *absolute* current limit, which is the current that will not be exceeded under any circumstance.

Because of the soft-clamp circuit, the actual current where the limit circuit begins to act is 20% below the absolute current limit.

If the output current is between this point and the Absolute Current Limit, the output response to the analog input setpoint is nonlinear. The result is that the drive current will asymptotically approach the absolute current limit, and will never exceed it even if the external modulation setpoint voltage far exceeds the current limit.

Figure 22 illustrates the behavior of the soft-clamp current limit. In this case the analog input voltage setpoint signal is a triangle wave, with the amplitude set so that the driver will attempt to overdrive the current limit.

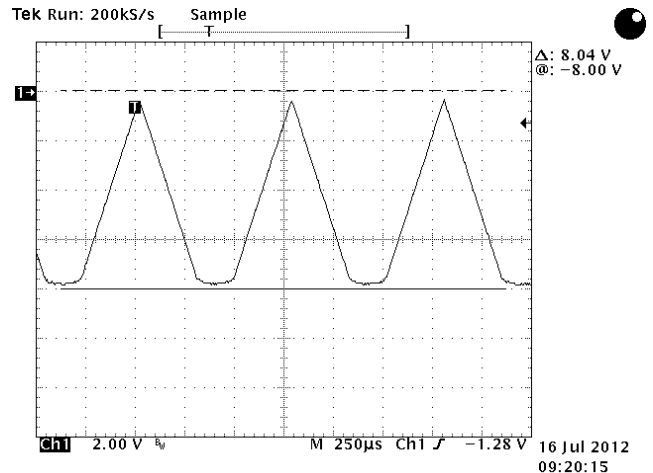

Figure 22. Soft Clamping Current Limit Behavior

SQUARE WAVE RESPONSE

Figure 23 and Figure 24 illustrate the modulation response of the QCL1500 driven at 1.15 A into a 10 Ω test load.

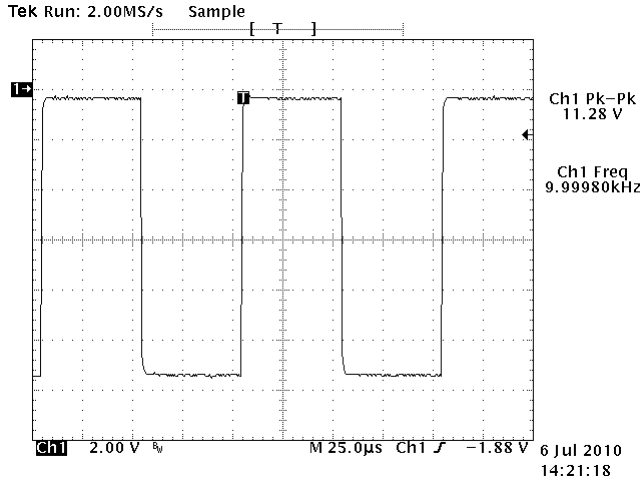

Figure 23. 10 kHz Output Plot
QCL1500 at 1.15 A with 10 Ω Test Load

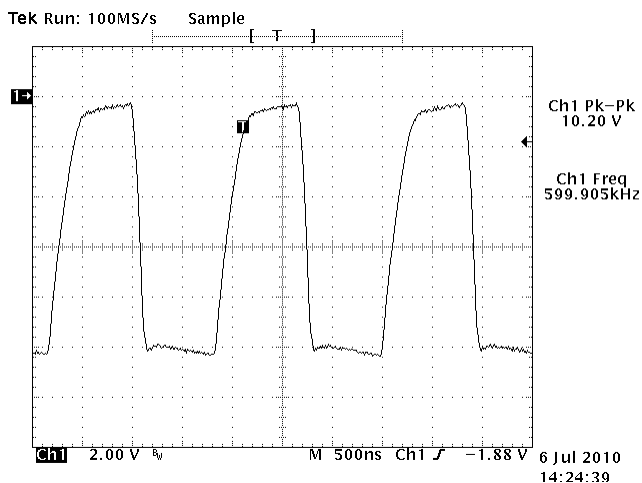

Figure 24. 600 kHz Output Plot
QCL1500 at 1.15 A with 10 Ω Test Load

REMOVE THE BAIL AND FEET FROM AN INSTRUMENT

To make sure there is the proper clearance between stacked instruments when rack mounting, the feet and bail must be removed.

On the underside of the instrument, using a Phillips head screwdriver, unscrew the four rubber feet.

UPDATE THE INSTRUMENT FIRMWARE

Updates to the instrument firmware are available on the Alpes Lasers website.

1. Turn the instrument completely off at both the front and rear panels.
2. On the Alpes Lasers website, download the ZIP file that is specific to your S - 4 model and save the update file to a flash drive.
3. Extract the file on the flash drive. It should contain the following files:
\\INSTALL.INI
\\QCLxx\\ABL.IMG
\\QCLxx\\APP.IMG
\\QCLxx\\INSTALL.INI
4. Insert the flash drive into the front DATA port on the instrument. Turn rear panel power on. The update automatically begins installation.
5. At the **Apply the firmware** screen, press **Yes**. The firmware update installs. Remove the flash drive.
6. Once the update is complete, press **OK** and reboot the instrument by turning off the front and rear panel power buttons and turning them back on again.

If you are upgrading from version 0.79 to version 1.5+, all calibration and user data will be converted and saved. If you downgrade from version 1.5+ to version 0.79, all existing calibration data will be lost.

DETERMINE WHICH FIRMWARE VERSION IS INSTALLED

With the rear and front panel power switches on, swipe the touchscreen from left to right to show the System Information screen.



Figure 25. System Information Screen

MECHANICAL SPECIFICATIONS

